

Operating Instructions



1	General Information	2
1.1	General Safety Notes	2
1.2	Intended Use	2
1.3	Conformity with EU Regulations	2
1.4	ATEX Approval	2
2	Transportation and Storage	2
3	Installation and Commissioning	2
3.1	Mechanical Installation	3
3.2	Electrical Connection	3
3.3	Devices with Diaphragm Seal	4
3.4	Mounting the Remote Display	4
4	Operation	5
4.1	Test Terminals	5
4.2	Remove Display / Activate Write Protection	6
4.3	Maintenance / Service	6
5	Disassembly	7
6	User Manual	8
6.1	Principles of the parameterisation concept	8
6.2	Basics of the Operating Concept	11
6.3	Display Mode / Measured Value Display	12
6.4	Menu Mode / Operating Menu	15
6.5	The Menu Tree	18

1 General Information

This document contains necessary information for the proper installation and use of this device. In addition to this instruction, be sure to observe all statutory requirements, applicable standards, the additional technical specifications on the accompanying data sheet (see www.labom.com) as well as the specifications indicated on the type plate.

1.1 General Safety Notes

The installation, set up, service or disassembly of this device must only be done by trained, qualified personnel using suitable equipment and authorized to do so.



Warning

Media can escape if unsuitable devices are used or if the installation is not correct.

Danger of severe injury or damage

- Ensure that the device is suitable for the process and undamaged.

1.2 Intended Use

The device is intended to measure pressure of gases, vapors and liquids as specified in the data sheet.

1.3 Conformity with EU Regulations

The CE-marking on the device certifies its compliance with the applicable EU Directives for placing products on the market within the European Union.

The following guidelines apply to these devices:

ATEX Directive	2014/34/EU
EMC Directive	2014/30/EU
PED Directive	2014/68/EU

You find the complete EC Declaration of Conformity (document no. KE_042) at www.labom.com.

1.4 ATEX Approval

If you purchased a device with ATEX approval, please refer to the accompanying document XA_010 or XA_011 for ATEX-relevant information.

2 Transportation and Storage

Store and transport the device only under clean and dry conditions preferably in the original packaging. Avoid exposure to shocks and excessive vibrations.

Permissible storage temperature: -40...80 °C

3 Installation and Commissioning

Ensure that the device is suitable for the intended application with respect to pressure range, overpressure limit, media compatibility, temperature range and process connection.

After the mechanical installation and electrical connection is completed, the device is ready for operation as soon as the power supply is switched on.

3.1 Mechanical Installation

Use gaskets, if required, that are suitable for the process connection and resistant to the media.

Before starting operation, check the process connection carefully for leaks under pressure.

You can use the device in any mounting position. Normally the transmitter is adjusted for a vertical mounting position. A different mounting position in combination with a small nominal range might cause a zero point offset. In this case a zero point adjustment might be necessary.

3.2 Electrical Connection

Complete the mechanical installation before you connect the device electrically.

Set up all electrical connections while the voltage supply is switched off.

Output (2-wire)	4...20 mA (20...4 mA)
Permissible supply voltage	$U_V = 12...30 \text{ VDC}$
Permissible load	$R_B \leq (U_V - 12 \text{ V}) / 22 \text{ mA}$

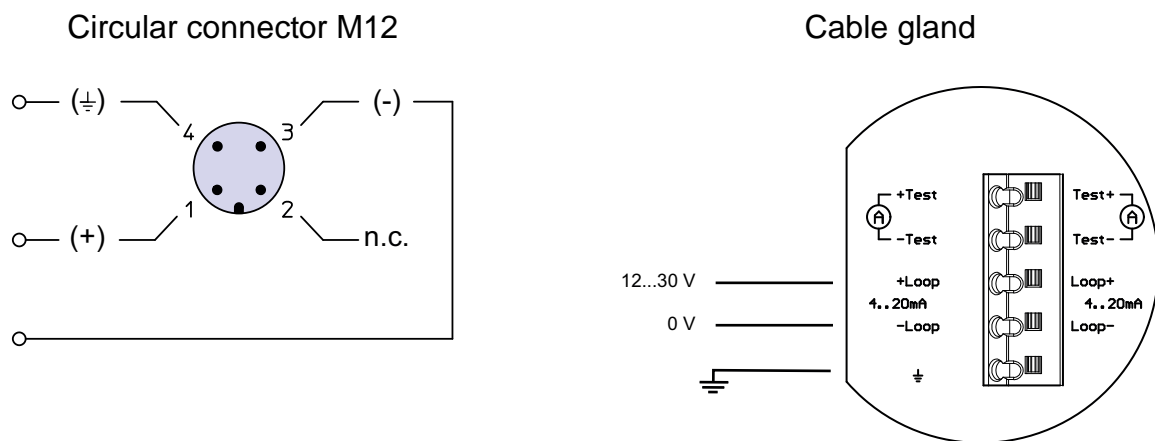

Figure 1: Options for the electrical connection

Pay attention to the following points regarding electrical connections via cable gland and terminal block:

- Do not forget to tighten the cable gland after the electrical connection is finalised.
- Press down the spring of spring-operated terminals as far as possible, e.g. with a screwdriver, before you insert the cable. Otherwise a safe electrical connection cannot be ensured.

3.3 Devices with Diaphragm Seal

Remove the protective cap or protective wrapping from the diaphragm only just before installation to prevent contamination or damage.

The diaphragm must not be touched. Do not place the device on its diaphragm. Even small scratches or deformations may negatively influence the zero point or other characteristics of the device.

Pressure transmitter and diaphragm seal are a closed system that must not be separated. You can find further information about diaphragm seals in the document TA_031 on www.labom.com.

3.4 Mounting the Remote Display

Optionally you can mount the display and control unit up to 10 m away from the measuring point in an additional housing. The back plate of the housing is universally suitable for wall mounting or pipe mounting for pipe diameters from 30 – 64 mm. For pipe mounting, you can order the corresponding U-bolts from LABOM.

For best EMC protection, only use the included cable.

If you ordered the remote display together with the device, the assembly has been completed in the factory. You only need to route the cable and mount the housing with the remote display.

If you have received the remote display as a retrofit kit, proceed as follows:

1. Unmount the front cover and the display unit from the PASCAL Ci4 (see 4.2).
2. Replace them with the adapter piece (round part with M12 socket) and front cover, which were screwed onto the remote display housing for shipment. Do not forget to connect the cable on the back with the display connector on the CPU module.
3. The cable may be shortened to on-site requirements. Colour codes on the terminals indicate which wire should be connected to which terminal (see Figure 2).
4. Mount the remote display housing using the mounting holes to a wall, a pipe or another suitable location.
5. Plug the M12 connector of the cable into the socket of the adapter piece.
6. Now connect the cable on the display module with the corresponding connector on the terminal board in the remote housing and insert the display module in the same manner as for the device itself (see 4.2).
7. The last step is to close the remote housing with the display cover that was previously on the device.

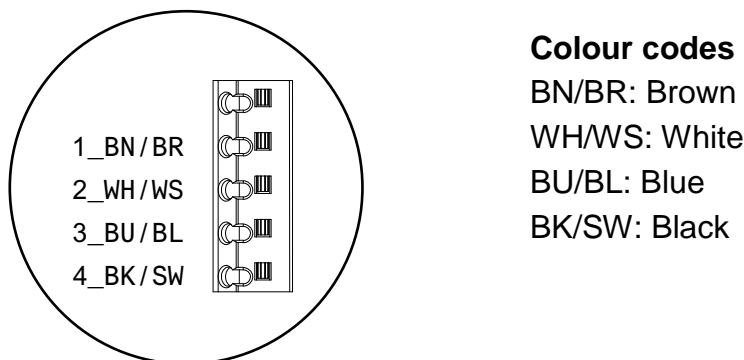

Figure 2: Connection of the remote display housing

This modification can be performed during operation. We do recommend, however, to switch off the device during the modification.

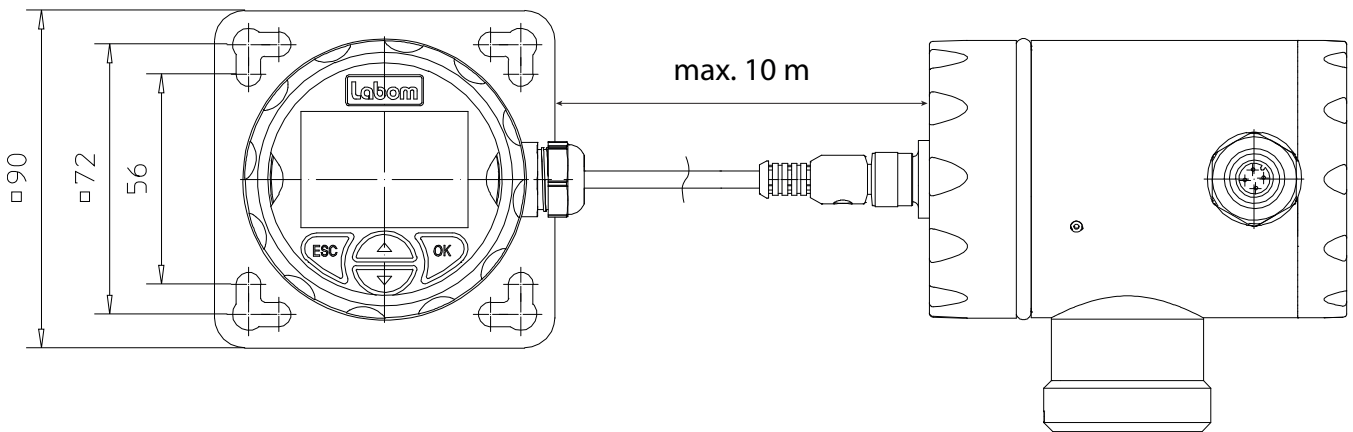

Figure 3: Remote display and control unit after installation

4 Operation

During operation, take care that the device remains within its intended pressure and temperature ranges. No other monitoring is necessary.

Permissible ambient temperature: $-40 \dots 80 \text{ } ^\circ\text{C}$

4.1 Test Terminals

You can check the output current without interrupting the current loop, using the test terminals on the terminal board. When you connect a current meter to the "+Test" and "-Test" terminals, the current is automatically routed through it.

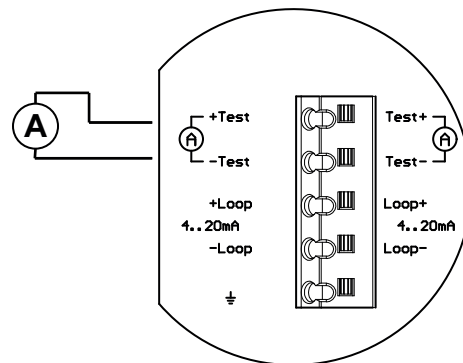

Figure 4: Current measurement during operation using test terminals

4.2 Remove Display / Activate Write Protection

Using the DIP switch in the device, you can disable changes to the configuration via the display or via HART (not for type series CI4xx3 with a process connection on the back).

To activate the write protection, you must first remove the display module. Proceed as follows:

- Unscrew the front cover
- Turn the display module 20° counterclockwise
- Lift off the display module carefully

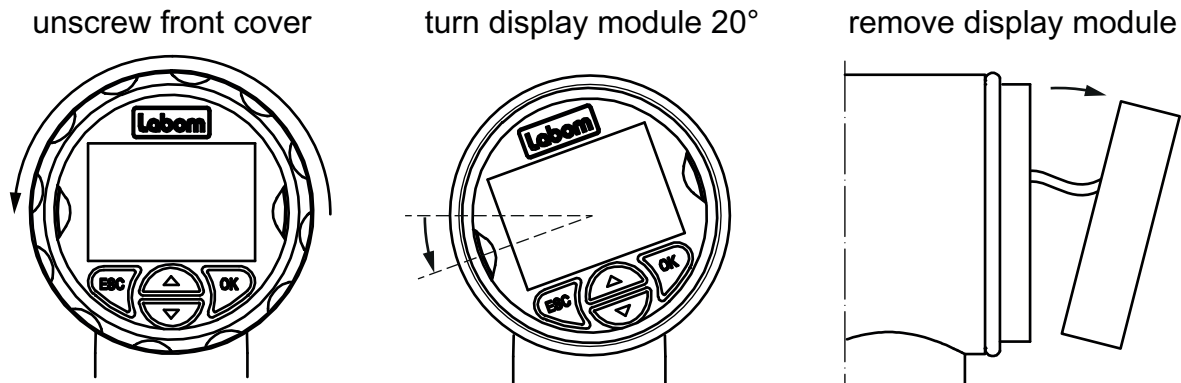

Figure 5: Removing the display

After removing the display module you can reach the DIP switch on the CPU module. The write protection is active when the DIP switch is in the "ON" position.

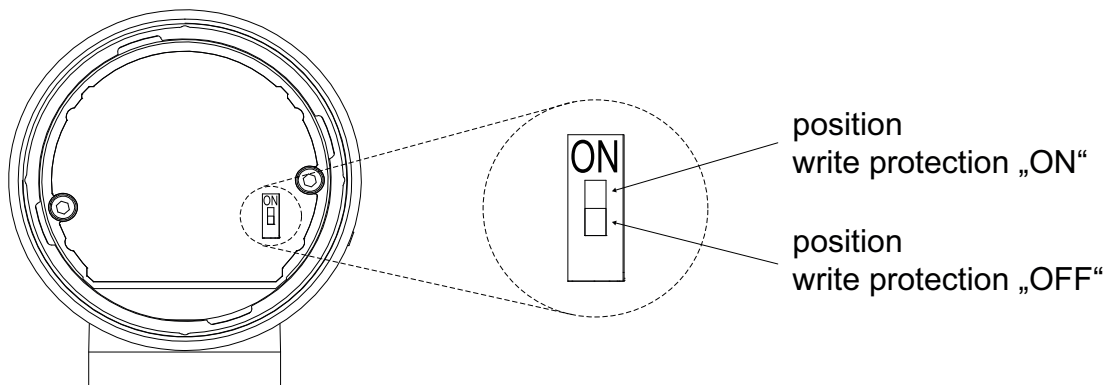

Figure 6: Write protection via slide switch in the device

Re-mount the display module in the reverse order.

4.3 Maintenance / Service

When properly installed in accordance with applicable specifications, this device is maintenance-free. However, we recommend an annual recalibration of the device.

In case of damage or defects, the customer can replace the following elements:

- Display module
- Cable glands (if applicable)

For defects to other components, repairs must be performed in the factory.

5 Disassembly

When measuring hot media, make sure that the device has cooled down prior to any dismounting or wear appropriate protective clothing to avoid burns.

Switch off the power supply to the device before disconnecting the electrical connections. Once this is done, the device may be mechanically removed.



Warning

Opening pressurized lines might cause severe injuries.

Danger of severe injuries or damage

- Relieve the process pressure before attempting to remove the device. Shut off the pressure supply for all feed lines to the device and relieve the pressure in them.



Warning

Hazardous deposits and residues might remain on opened process connections and removed devices.

Danger of injury

- After the device has been removed, seal off the measuring point and mark the open process connection accordingly. Consider a possible danger due to residues when handling the removed device.

6 User Manual

The device can be configured via the display module as well as the HART protocol. The following pages describe operation and configuration of the device using the display module. (valid from display module software version 2.0.0).

An overview of the menu structure can be found on the last page of this document.

6.1 Principles of the parameterisation concept

Basic requirement for correct level measurements are correct pressure measurements. Please note in particular that the mounting position may lead to a change of the measured value. Therefore, use the position correction feature in the adjustment menu once it is installed and before the commissioning (see 6.5.4.2).

The following information is required for the hydrostatic fill level measurement:

- Density of the medium
- Reference point for fill level values (fill level zero)
- Tank shape (for fill volume and weight)

The fill height can be calculated from the measured pressure using the density. The level measurement is decoupled from the pressure measurement by using the level zero. The size and shape of the tank must be defined for calculating the volume and weight.

NOTE: It would be physically correct to refer to the fill amount as a mass. However, the not quite correct term "weight" is recognised in everyday language. The aim of the parameterisation concept is to realise an intuitive access. The term "fill weight" and not "fill mass" is therefore used below.

6.1.1 The reference point for level values

The reference point for level values indicates which level should correspond to a fill height of zero metres. You can select this reference point for the level (level zero) regardless of the position of the process connection (pressure zero).

The reference point is parameterised by entering the height offset. This indicates the height difference between the pressure zero and the level zero. A positive height offset means that the level zero is above the pressure zero. The level zero is below the pressure zero for a negative height offset.

Set the height offset to zero if the level zero is at the height of the process connection.

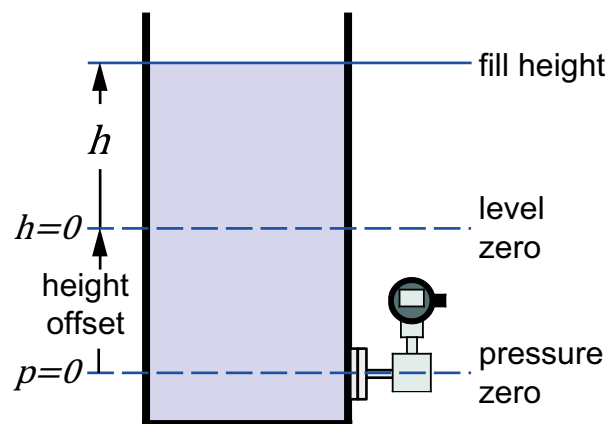

Figure 7: Linking the level zero and pressure zero using the height offset

The level measurement is decoupled from the pressure measurement by using the height offset. All level measurement parameters and measured values refer to the level zero.

6.1.2 Tank shape

The fill height is converted to a fill volume using the tank shape table.

The table is stored in the device as a series of fill height/fill volume pairs. The tank shape table can therefore be easily determined from the tank documentation. A conversion into percent or the like is not necessary.

It is also possible to teach in the tank shape to depict complex geometries in the tank shape table such as agitators, for example (see 6.5.3.4).

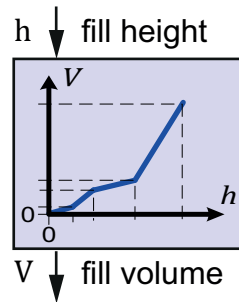

Figure 8: Calculating the fill volume using the tank shape table

The control points of the tank shape table are entered and stored as height/volume pairs. This means that a change in density does not affect the tank shape definition.

The table is managed internally in metre/litre pairs and converted for the display depending on the units selected. The display therefore adapts accordingly to the table when converting the height and volume unit.

6.1.3 Scaling the current output

Each of the level variables (height, volume, weight) - as well as the measured pressure for calibration purposes - can be issued at the current output. The scaling is done by indicating a measured value at 4 mA (lower range value) and a value at 20 mA (upper range value). The limit values are entered in its unit depending on the output variable selected.

These values, like all level variables, relate to the level zero.

The scaling of the measurand (height, volume, weight, pressure) are independent of each other. A separate pair of values at 4 and 20 mA are stored in the device for each measured variable.

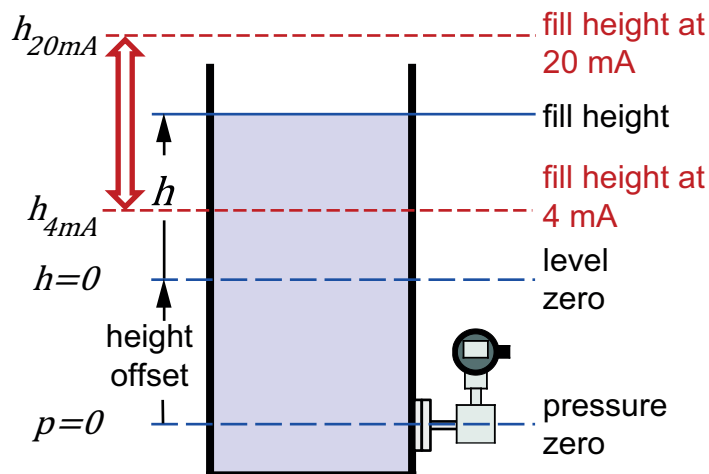

Figure 9: Scaling the current output

6.1.4 Calculating the fill weight

If a fill volume is available, the device calculates the fill weight from it using the density. The fill volume and weight are proportional to each other.

The level zero is also the reference point for the fill weight.

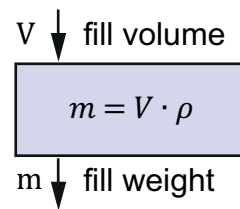

Figure 10: Calculating the fill weight from the fill volume

6.1.5 Summary of the parameterisation concept

1. The fill height is calculated from the measured pressure using the density and height offset.
2. The fill volume is calculated from the height using the tank shape table.
3. The fill weight is calculated from the volume using the density.
4. A manual selection determines which of these measurands should be issued at the current output.
5. The current output is scaled using the parameters "Value at 4 mA" and "Value at 20 mA".

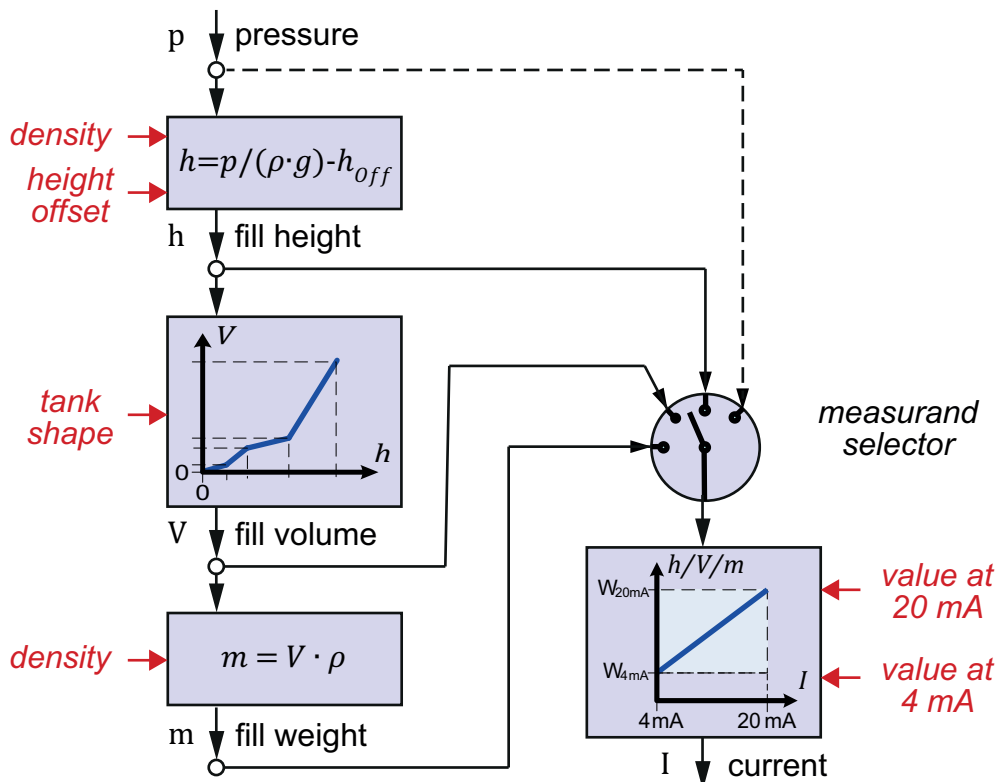

Figure 11: Schematic diagram of the fill level measurement

6.2 Basics of the Operating Concept

The display module consists of a dot-matrix display with 80x120 pixels as well as a 4-button control panel.

The four buttons below the display allow an intuitive operation of the device. The general functionality of the buttons is identical in all operating modes.

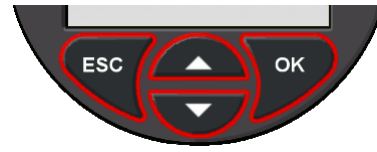

Figure 12: Control elements

If you press and hold the up or down button, it will automatically be triggered multiple times. This allows to easily navigate through longer selection lists. If you press and hold the ESC button, you always return to the measured value display.

Button	Function
△ / ▽	Select function, increase/decrease value
OK	Confirm selected function or selected value
ESC	Cancel action
ESC long	Return to measured value display

Table 1: General button functions

The structure of the display is the same in every operating mode. The display area is divided into four zones:

- Header
- Icon indicating device status
- Data area
- Bar graph related to the currently measured value

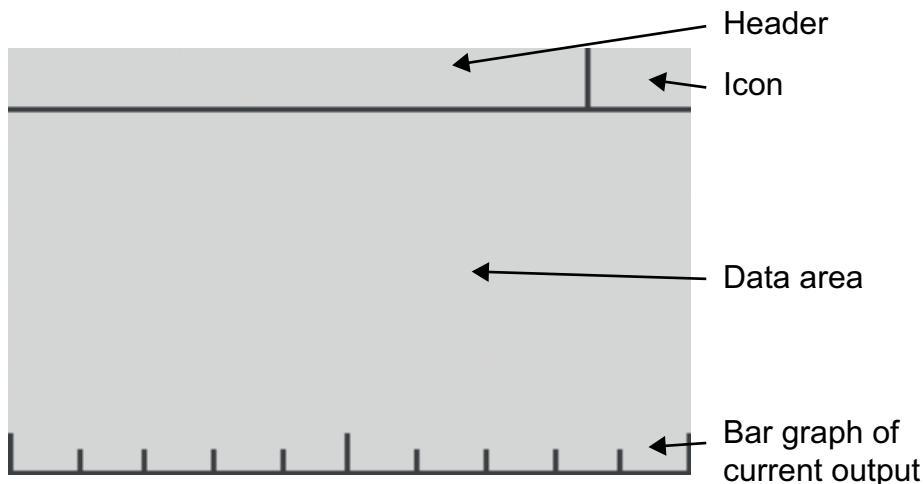

Figure 13: Display structure

The icon for the device status (see 6.3.3) as well as the bar graph is displayed in each operating mode. The bar graph always shows the state of the current output (4 mA = 0%, 20 mA = 100%). The contents of the header and the data area depend on the operating mode:

Display of measured value

- Header: Icon description, if applicable. Otherwise "Value"
- Data area: Measured values and parameters according to the selected display mode (see 6.3.4)

Display of device data (see 6.3.1)

- Header: Title for the displayed device data
- Data area: Device data

Operating menu

- Header: Selected menu item
- Data area: Submenu or dialogue during setting procedure

6.3 Display Mode / Measured Value Display

After applying the supply voltage and completion of the initialisation, the device switches to the display mode. In the display, the currently measured value is shown.

If the measured value is larger than the displayable number due to setting a fixed decimal point, the largest displayable number is shown flashing. In this case please select a different setting of the decimal point.

In display mode you can review the device data, enter the menu or lock/unlock the menu.

Button	Function
△ / ▽	Scroll through the pages with device data
OK	Go to the operating menu
ESC	Return to measured value display
ESC+OK	Activate / deactivate menu lock (see 6.3.2)

Table 2: Button functions in display mode

6.3.1 Quick Access to Device Data

You can access a number of device parameters directly from the measured value display using the △ / ▽-buttons. This allows a quick overview of the device configuration.

With the △-button you can display variable data (trailing pointers and counters), with the ▽-button static information such as configuration data.

From any screen of the device data, you can enter the operating menu with OK and go back to the measured value display by pressing ESC.

The sequence of the screens with device data is as follows:

- △ Counter (operating hour counter, maintenance timer)
- △ Min/Max-values (fill height and sensor temperature)
- ----- Measured value display (starting point) ---
- ▽ Pressure measurement (nominal range, damping, measuring rate)
- ▽ Fill level measurement (measurand, density, height offset etc.)
- ▽ Current output (characteristic curve, alarm current, limits)

- ▾ HART data (address, tag, descriptor, date)
- ▾ Device identification (device ID, order number, serial number)
- ▾ Module information (hardware and software versions, serial numbers)

6.3.2 Locking the Menu

You can lock the menu with a key combination at the device. Press and hold the ESC-key and press then OK to activate the menu lock. You can still access the device data but the menu is now locked.

An active menu lock is indicated by the header text „Menu locked“ in combination with the lock icon.

Use the same key combination to unlock the menu again. The menu cannot be unlocked with the key combination if the hardware DIP-switch is activated.

6.3.3 Icons indicating device status

In the top right corner of the display, depending on the device status an NE107-conform icon is displayed. The following icons are defined:







	Error/failure	Critical error, alarm current is activated The error description is indicated in the display. The operating menu can still be opened.
	Warning	Temperature or pressure limits are exceeded, faulty ATC sensor (for devices including the ATC option).
	Saturation	The output current has reached the pre-set upper or lower current limit.
	Function control	The output current corresponds to the measured value or current simulation, but not to the applied pressure value.
	Maintenance	The device indicates necessary maintenance due to maintenance timer settings (see 6.5.7.2).
	Write protection	The write protection of the device was activated via the DIP switch or with the key combination in the display.

Table 3: Icons for device state

The list of icons is sorted in descending priority. Only the icon with the highest priority is shown. The two most important icons for fault and/or warning are flashing when displayed.

6.3.4 Display layouts

You can configure the layout of the measured value display as well as the displayed information individually. There are seven different layouts available:





Designation	Layout	Description	Example
Fill level 4 values		Three secondary values are displayed under the main value. Vertical bargraph	
Fill level 2 values		Two values are shown in the same size, one below the other. Vertical bargraph	
Five values		Under the main value, four additional values are shown. Horizontal bargraph	
Four values		Under the main value, three additional values are shown. One of these can use the entire display width. Horizontal bargraph	
Three values		Under the main value, two additional values are shown. Both of them can use the entire display width. Horizontal bargraph	
Two values		Two values are shown in the same size, one below the other. Horizontal bargraph	
Large display		The main value is shown at the maximum size (best readability from a distance). One additional value can also be shown. Horizontal bargraph	

Table 4: Display layouts

The horizontal bargraph is always used in menu mode regardless of the selected layout. You can define what information shall be shown in the layout's placeholders. You can select the 1st value (main value) from the following data:

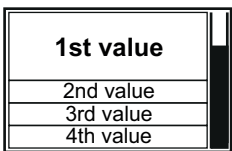
- Fill height in the selected unit
- Fill volume in the selected unit
- Fill weight in the selected unit
- Pressure in the selected unit
- Current in percent
- Current in mA

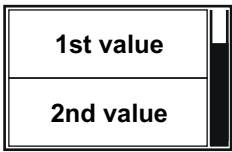
For all further values, you can additionally choose from the following data:

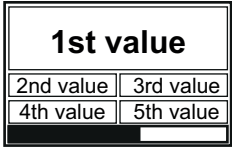
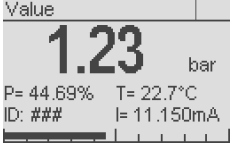
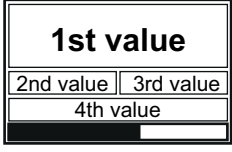
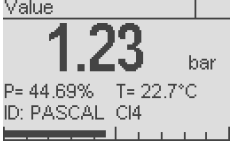
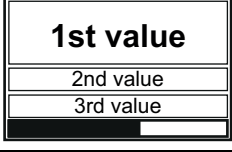
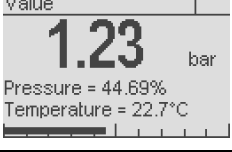
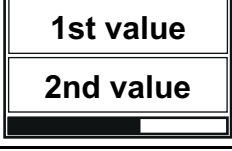
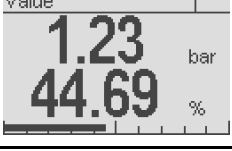
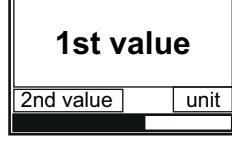
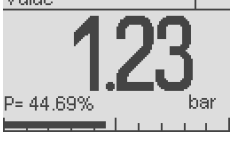
- Sensor temperature
- ATC temperature (for devices including the ATC option)
- Density
- Device ID (see 6.5.10.1)
- HART tag
- HART descriptor

When information (such as the device ID) cannot be displayed in a short layout placeholder, "###" appears on the screen. Then select another layout or assign the value to a longer layout placeholder.

You can configure the display mode in the operating menu (see 6.5.5.2).

6.4 Menu Mode / Operating Menu

Press OK in the measured value display to go to the operating menu. Then the main menu appears in the display.

In the operating menu you can navigate in the menus by using the arrow buttons. The selected menu item is indicated by triangles on the left and right. The OK button selects the menu item or switches to the corresponding submenu. You can return to the higher-level menu by pressing ESC. From the main menu, pressing ESC returns to the measured value display.

From every position in the operating menu, you can return to the measured value display by pressing and holding the ESC button (for at least one second).

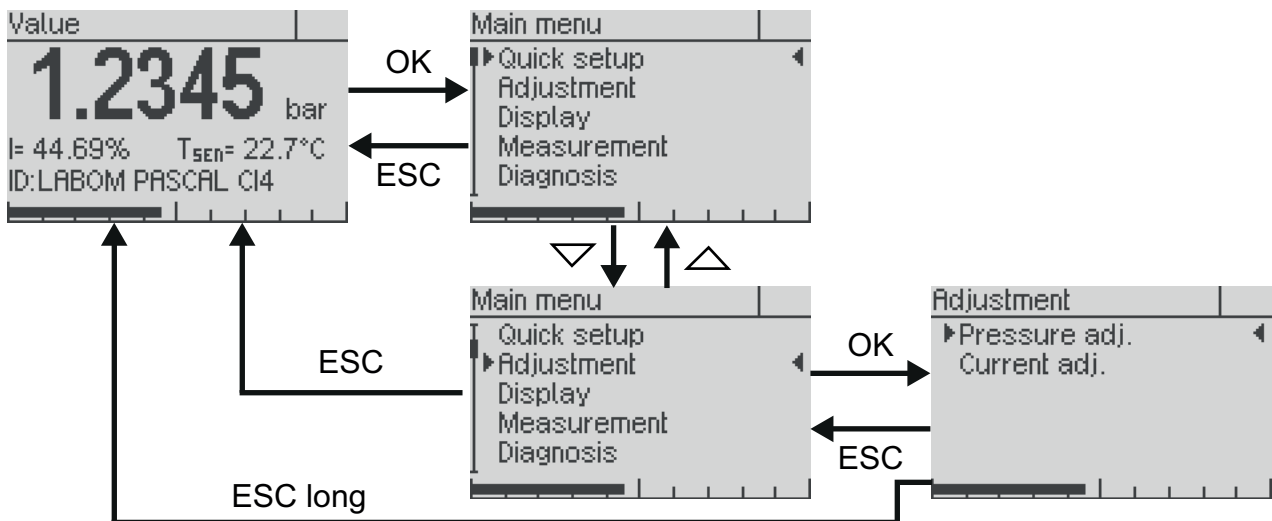

Figure 14: The Operating menu

In long menus and selection lists, a scroll bar on the left side shows the position of the currently selected item.

Menu items that open a setting dialogue differ from submenus by three trailing points, e.g. "Lower range ..." (setting dialogue) and "System" (submenu).

If no button is pressed in menu mode for five minutes, the device automatically returns to the display mode without saving any values.

Button	Function
△	Scroll up in the menu, increase value/position in list
▽	Scroll down in the menu, decrease value/position in list
OK	Select menu, confirm value/list entry
ESC	Cancel the data entry or menu selection, return to the next higher menu
ESC long	Cancel menu mode, return to display mode

Table 5: Button functions in the operating menu

6.4.1 Displaying and entering parameters

When entering parameters, either numerical inputs or a selection lists with fixed options is available.

In general, the actual selection will be displayed first (view mode). Press OK to switch to edit mode to change the parameter. After this is done, the display will then switch back to view mode so that you can check the new setting.

6.4.1.1 Selection of a value from a selection list

Up to three options are shown at the same time in one selection list. When the selection list is longer, a scroll bar on the left side of the display indicates the position of the selected item in the selection list.

When you press the ESC button, you cancel the entry and go back to view mode. The selected value is not saved.

With the OK button, the selected value is saved. Saving the value is confirmed with an information window and the new value is shown in view mode.

With ESC, you leave the view mode and return to the menu.

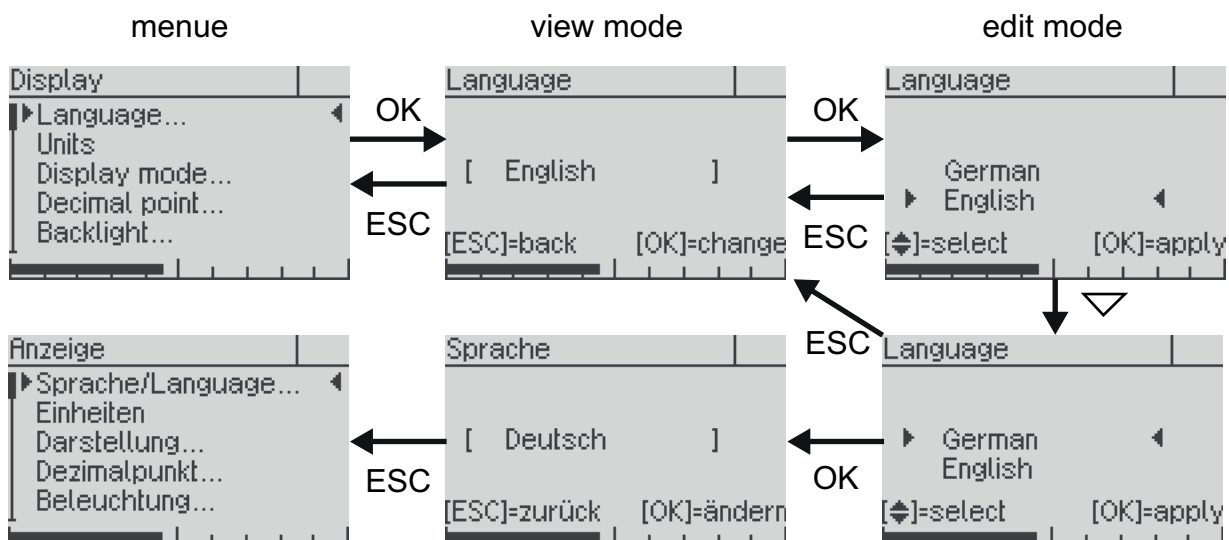

Figure 15: Procedure for value selection (e.g. changing language from english to german)

6.4.2 Setting a numeric value

When setting numeric values, the screen shows the following elements (from top to bottom):

- Designation of the parameter that can be set
- Help text (if applicable)
- Numeric value and unit
- Function of buttons
- Bar graph

After selecting a menu item for numerical entry (e.g. damping), at first the value is displayed only. The numeric value itself is shown in square brackets and its unit behind it. Unused leading digits are marked with bottom lines. You need to press OK again to enter the edit mode.

Numeric values are entered digit by digit. First, always the leftmost digit is selected (visible with a triangle above and below the number). By pressing OK, you go to the next digit.

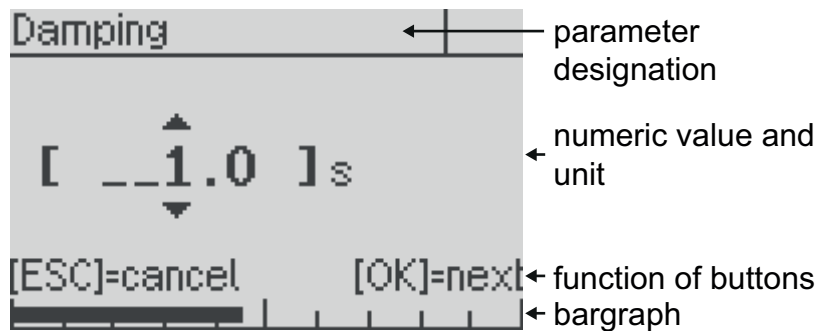

Figure 16: Elements when setting a numeric value

You change the selected digit by pressing the \triangle or ∇ button. The higher value digit is also increased or decreased when passing zero. For instance, you can easily go from 19 to 20 without having to edit two digits.

Lower value digits are not influenced, unless the parameter limit is reached. The value is then set to the parameter limit.

You can set negative numbers by decreasing the value below zero.

When you press the ESC button, you can cancel the entry at any time and return to the display of the set value. Any change of the value is not saved.

With the OK button you confirm the set digit value and jump to the next digit.

When you confirm the rightmost digit, the entire value is saved. You can save the new value from any digit by pressing and holding the OK button.

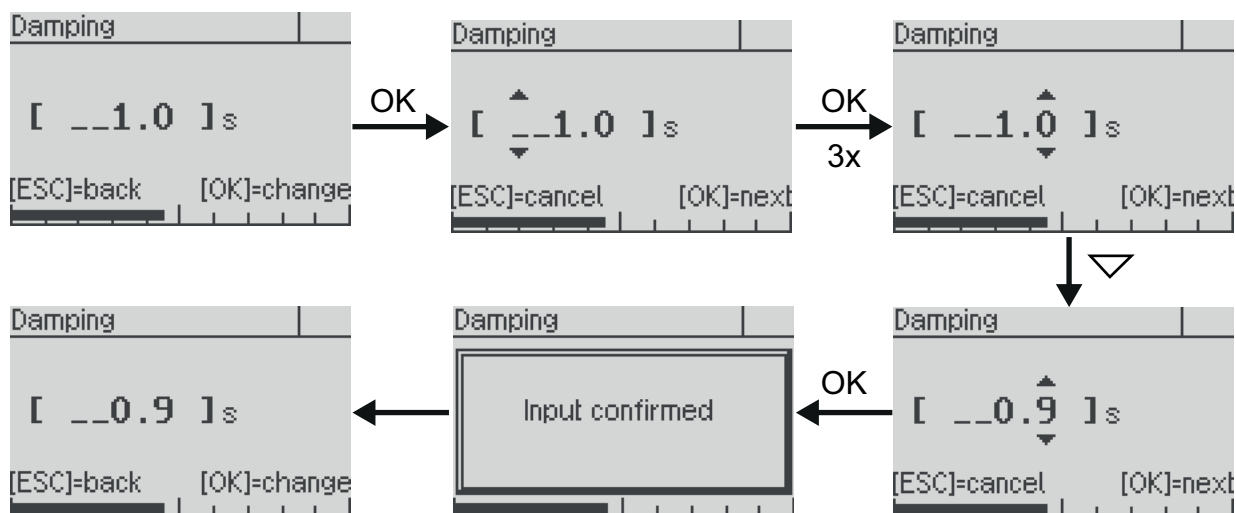

Figure 17: Procedure for setting a numeric value (e.g. from 1.0 to 0.9)

6.5 The Menu Tree

In the following, the display and adjustment options are described by their position in the menu tree. An overview of the menu tree can be found on the last page of this document.

6.5.1 Main menu

The main menu has the following entries:

Menu entry	Description
Quick setup	Selection of the most important settings
Level	Parameterisation of level measurement
Adjustment	Adjustment functions for pressure measurement and current output
Display	Functions for configuring the display
Measurement/output	Configuration of the measuring rate, damping and current output
Diagnosis	Diagnostic information such as min/max values
Simulation	Simulation of current or one of the possible measurands for function check of the measurement chain
Communication	Information and settings regarding HART communication
System	Device data and function such as factory reset

Table 6: The main menu

6.5.2 „Quick Setup“ menu

In Quick Setup, basic configuration options are combined to make it possible to quickly configure key functions. All functions of the quick setup can also be found at another position in the menu tree.

The following functions are available in the Quick Setup menu:

Menu entry	Description
Sprache/Language	Select menu language
Level wizard	Guided parameterisation of the fill level measurement (see 6.5.3.1)
Damping	Setting the damping of the output signal (see 6.5.6.1)
Device ID	Setting the device ID (see 6.5.10.1)
Config.-memory	Configuration memory: reading, writing and status (see 6.5.10.3)

Table 7: "Quick Setup" menu

6.5.3 "Level" menu

All settings to parameterise the level measurement can be found in the "Level" menu.

Menu item	Description
Level wizard	Guided parameterisation of the fill level measurement
Density	View/change or teach-in the density and select a unit
Height offset	View/change or teach-in the height offset and select a unit
Tank shape	Enter, teach-in and manage the tank shape for volume and weight measurement
Status	Display the status of the level measurement

Table 8: "Fill level" menu

6.5.3.1 Level wizard

The fill level wizard allows the easy parameterisation of the device. You are guided through all the necessary setting dialogue boxes.

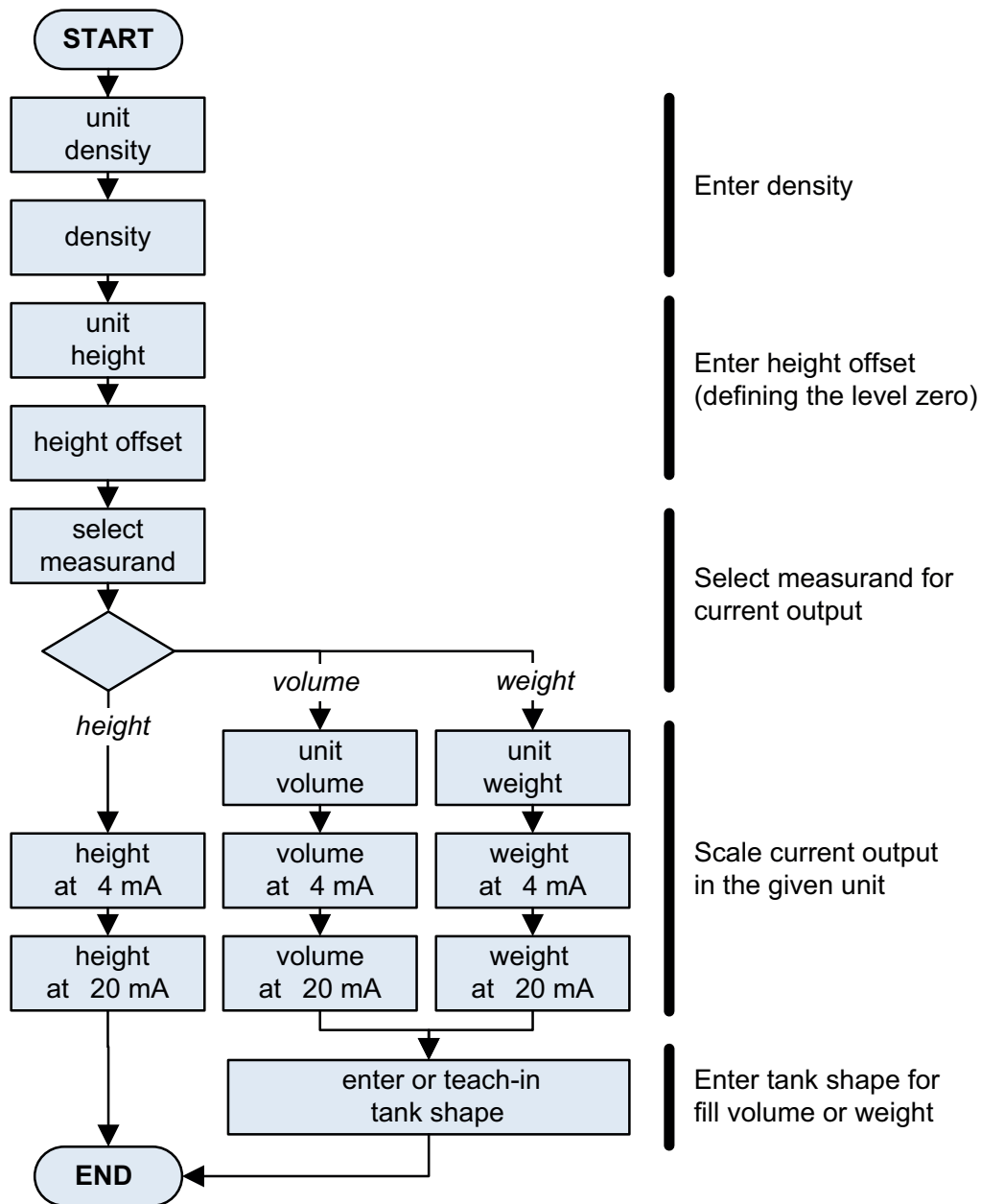

Figure 18: Guided dialogue boxes in level wizard

6.5.3.2 "Density" submenu

You can view, change or teach in the density in this submenu. You can also select the density unit.

Menu item	Description
Description	View / change the density
Teach-in	Teach-in the density
Unit	Select the unit for the density

Table 9: "Density" submenu

Teaching-in the density

You can also teach-in the density on the tank. A basic requirement is that the height offset is correctly set and the fill height (relative to the level zero) can be determined with sufficient accuracy.

The device calculates the density from the measured pressure and the entered fill height and suggests the density to be saved.

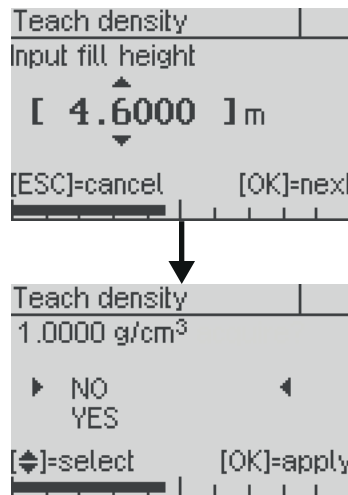

Input of current fill height based on level zero

Density calculated by device and suggested for storage

Figure 19: Teaching-in the density

6.5.3.3 "Height offset" submenu

You can view, change or teach-in the height offset in this submenu. You can also set the unit for the height offset (and the fill height).

Menu item	Description
View / change	View / change the height offset
Teach-in	Teach-in the height offset
Unit	Select the unit for the height

Table 10: "Height offset" submenu

Teaching-in the height offset

You can also teach-in the height offset on the tank. A basic requirement is that the density is correctly set and the tank is filled to level zero with sufficient accuracy.

The device calculates the height offset (distance from pressure zero to level zero) from the current pressure and the density entered and suggests that value for the height offset.

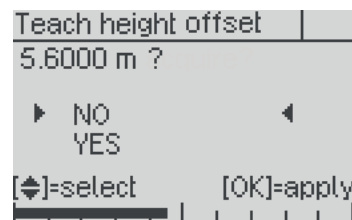

Figure 20: Teaching-in the height offset

6.5.3.4 "Tank shape" submenu

Parameterise and manage the tank shape table that is used to calculate the volume from the fill height in the "Tank shape" submenu.

The tank shape pairs serve as control points of a tank shape curve. The volume is interpolated linearly between the tank shape pairs. The volume value is extrapolated from the last straight line above the last control point.

Menu item	Description
View / change	View / change the tank shape
Teach-in	Teach-in the tank shape
Units	Select units for the height and volume
Switch on/off	Activate or deactivate the tank shape
Delete a control point	Delete a control point from the tank shape table
Delete a tank shape	Delete the entire tank shape table

Table 11: "Density" submenu

Enter or teach-in the tank shape

A basic requirement for the correct recording of the tank shape is the correct parameterisation of the density and height offset.

Entering and teaching-in the tank shape can be combined as required. For example, you can teach-in the torispherical head of a tank and enter the cylindrical part of the tank by adding control points manually.

It is mandatory that the fill height 0 m corresponds to the volume 0 m³ (or in other units). Therefore, make sure that you add a 0/0 point when you enter the tank shape manually. Otherwise, the volume values may be shifted in an undesired manner when switching on the tank shape to achieve a 0/0 point (see below).

You can select any fill ratio at the start of the teach-in process. You don't have to start with the teach-in process at the height of the pressure zero or the height of the level zero.

You can teach-in the tank shape by filling or emptying. Enter the volume filled into or removed from the tank during the teach-in process. This volume, together with the measured fill height, is stored as a control point of the tank shape table.

It makes sense to start the teach-in process by entering a volume of zero m³ (or in other units). Enter the volume filled since the start for each control point when teaching-in by filling. Enter the volume removed since the start with a negative sign when teaching-in by emptying. When switching on the tank shape, the control points are sorted and adjusted in such a way that a valid table is created with a reference to the level zero (see below).

Switching the tank shape on/off

The tank shape can not be edited and used for the volume calculation at the same time. It must be switched off before changing or teaching in the tank shape. The set alarm current is then issued at the current output if the volume or weight is selected as the measurand.

The following steps are performed when switching on the tank shape:

- Sorting control points in rising order according to height
- Deleting closely spaced control points (height difference $<0,1$ mm)
- Checking if the volume values are also arranged in rising order
- Adjusting the volume values if necessary so that the compensating curve runs through the $0\text{ m} / 0\text{ m}^3$ point

Control points can be deleted and added very easily by means of automatic sorting. For example, if a further control point is required to achieve the necessary accuracy, this can easily be added at the end of the table. This is shifted to the correct point in the control point list when switching on the tank shape by means of a.m. automatic sorting.

If the same fill height is taught-in twice by mistake during the teach-in process, two control points will be very close together, which can lead to problems with the volume calculation. The odd control point is deleted after checking for closely located control points.

Checking the volume values avoids input errors. The table cannot be switched on if the volume values are not also sorted in rising order after sorting the height values.

The level zero applies to all fill level variables. Consequently, the height value 0 m must always correspond to the volume 0 m^3 (or in other units). This is ensured by adjusting the volume values when switching on the table in such a way that the compensating curve runs through $0/0$.

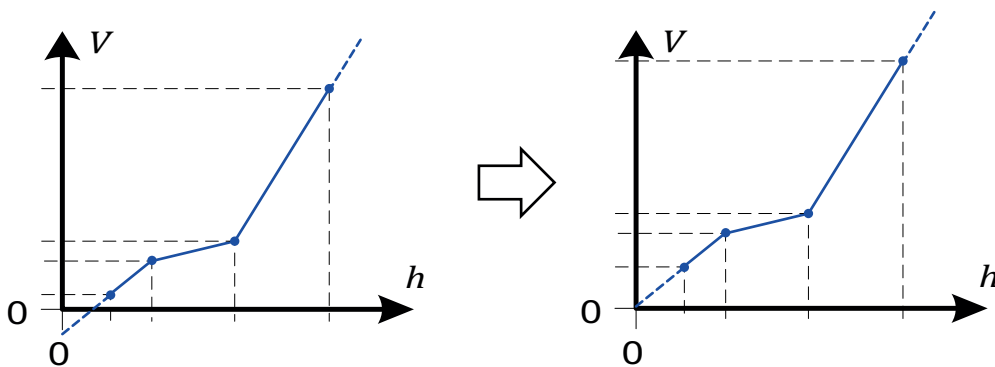

Figure 21: Shifting the tank shape table

A taught-in table is converted into the necessary format automatically by sorting and adjusting. The following figure shows an example of the process.

A tank shape was taught-in with four control points by emptying the tank. The first control point with a full tank (here 0 m^3) is the reference point for additional volume figures. 2 m^3 were discharged before reaching the second control point. A further cubic metre was discharged before reaching the third control point, i.e. 3 m^3 in total. The level zero corresponds to the lower edge of the outlet. The flow meter indicates $3,6\text{ m}^3$ after emptying the tank. That is the volume value for the last control point.

The height values are sorted first when switching on the table. Then all volume values are adjusted by $3,6\text{ m}^3$ so that a fill height of zero corresponds to a volume of zero.

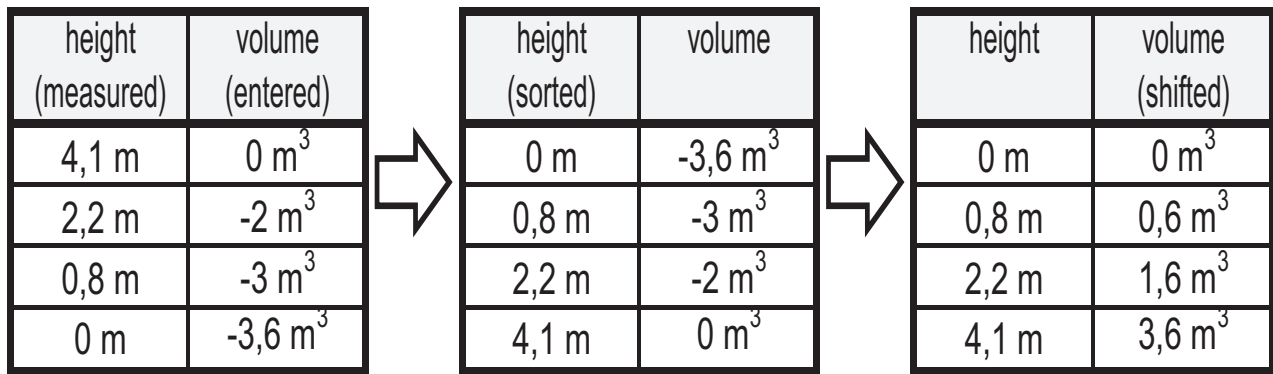

Figure 22: Automatic sorting and adjusting control points

6.5.4 "Adjustment" menu

The following functions are available for the adjustment:

Menu entry	Description
Zero point	Set device at ambient pressure to zero (0 bar rel) (<i>not with absolute pressure devices</i>)
Position correction	Correct zero point error due to installation position (<i>not with absolute pressure devices</i>)
Lower adjustment	Offset correction with applied reference pressure
Upper adjustment	Span correction with applied reference pressure

Table 12: "Pressure Adjustment" menu

6.5.4.1 Zero-point correction

The zero-point correction requires a non-pressurized pressure port e.g. during calibration in the lab. When executing this function the applied pressure will be interpreted as zero bar relative pressure.

The zero point correction results in an offset of the whole characteristic curve. Therefore it is a special case of the lower adjustment (see below).

6.5.4.2 Position correction

Using the function "Position correction", you can correct the offset error due to the installation position independent of the zero-point offset.

In the corresponding submenu, you will find the following entries:

Menu entry	Description
Pos.corr. on/off	Activate/deactivate position correction
Set pos. corr.	Correct position error at ambient pressure

Table 13: "Position Correction" submenu

When you set the position correction, it will be activated automatically. You can deactivate the position correction, for instance for a subsequent calibration to check the zero point independently from the installation position.

6.5.4.3 Upper and lower adjustment

The lower adjustment results in an offset of the characteristic curve. It thus affects zero and span of the measuring range.

The upper adjustment changes the slope of the characteristic curve by correcting the span of the measuring range.

Execute the lower adjustment prior to the upper adjustment for a correct full adjustment.

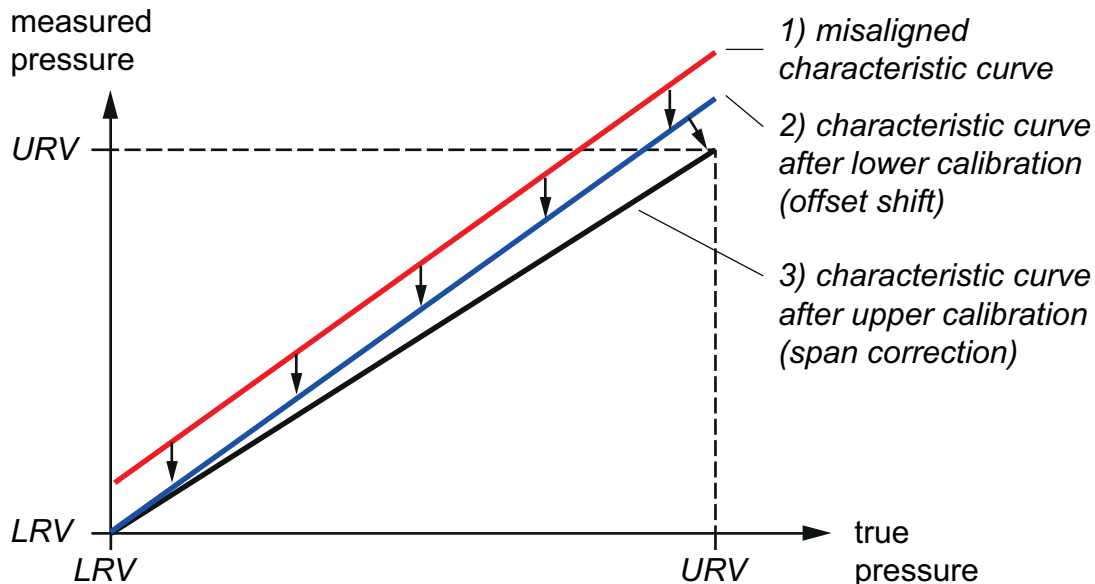

Figure 23: Effect of the upper and lower adjustment on the characteristic curve

You can perform the upper and lower adjustment at any reference pressure level. For instance, you can perform the lower adjustment of a -1...4 bar device at -900 mbar rel. The reference pressure level for the upper offset can also be freely chosen. For an exact adjustment, however, it should be as close to the upper range value as possible.

6.5.4.4 Current adjustment

You can use the current adjustment, if the reading at the end of the measurement chain (re-converted current value) does not correspond to the measured pressure. With this function you can compensate deviations in the output stage as well as the downstream measurement chain.

Proceed as follows (example for 4 mA):

- Select function "Current adjustment" → "4mA"
- Use "OK" to activate constant current mode (4 mA). CAUTION! The output current value now no longer corresponds with the measured pressure! This is indicated by the icon "Function check" (see 6.3.3).
- Read the displayed current value at the end of the measurement chain.
- Enter this current value (e.g. 3.996) at the device. The device now corrects the current output so that 4 mA are shown at the end of the measurement chain.

When leaving the function, the constant current mode is disabled and the current value corresponds again to the measured pressure.

6.5.5 "Display" menu

In the "Display" menu, you find all the settings that affect the display on the screen.

Menu entry	Description
Language	Select menu language
Units	Setting units for the different measured and displayed values
Display mode	Configuration of the display layout and content (see 6.3.4)
Decimal point	Select setting of decimal point to determine number of decimal places
Backlight	Switch backlight on/off

Table 14: "Display" menu

6.5.5.1 "Units" submenu

You can select the unit of every value shown on the display. These settings do not affect the internal calculations of the device.

The shown conversions are only meant for your orientation. The device uses conversion values with ten decimal places.

The unit selection in this submenu only affects the display on the screen. Communication via HART is performed using the unit set in the HART driver.

Fill height unit

The unit in which the measured fill height should be displayed can be selected from the following list. This is also the unit for the height offset.

Unit	Description
mm	Millimetre (1 mm = 0.001 m)
cm	Centimetre (1 cm = 10 mm = 0.01 m)
m	Metre (1 m = 100 cm = 1000 mm)
ft	Foot (1ft = 12 in = 30.48 cm)
in	Inch (1 in = 1/12 ft = 25.4 mm)
yd	Yard (1 yd = 3 ft = 36 in = 0.9144 m)

Table 15: Possible fill height units

Volume unit

The unit in which the measured volume should be displayed and entered in the tank shape table can be selected from the following list:

Unit	Description
m ³	Cubic metre (1 m ³ = 10 ⁶ cm ³ = 10 ⁹ mm ³ = 1000 l)
l	Litre (1 l = 1000 cm ³ = 0,001 m ³)
hl	Hectolitre (1 hl = 100 l = 0,1 m ³)
in ³	Cubic inch (1 in ³ = 16,387 cm ³ = 0,016387 l)
ft ³	Cubic foot (1 ft ³ = 12 ³ in ³ = 28,317 l)
yd ³	Cubic yard (1 yd ³ = 27 ft ³ = 0,764555 m ³ = 764,555 l)
gal	US gallon (1 gal = 3,785 l)

Table 16: Possible volume units

Weight unit

The unit in which the measured weight should be displayed can be selected from the following list.

Unit	Description
g	Gramme (1 g = 0,001 kg)
kg	Kilogramme (1 kg = 1000 g = 0,001 t)
t	Tonne (1 t = 1000 kg)
lb	Pound (1 lb = 0,4536 kg)

Table 17: Possible weight units

Density unit

The unit in which the density should be entered and displayed can be selected from the following list.

Unit	Description
g/cm ³	Gramme per cubic metre (1 g/cm ³ = 1 kg/l = 1 t/m ³)
kg/m ³	Kilogramme per cubic metre (1 kg/m ³ = 0,001 g/cm ³)
kg/l	Kilogramme per litre (1 kg/l = 1 g/cm ³ = 1 t/m ³)
t/m ³	Tonnes per cubic metre (1 t/m ³ = 1 g/cm ³ = 1 kg/l)
lb/ft ³	Pound per cubic foot (1 lb/ft ³ = 16.018 kg/m ³)
lb/in ³	Pound per cubic inch (1 lb/in ³ = 27.68 g/cm ³)

Table 18: Possible density units

Unit Pressure

The unit in which the measured pressure is to be shown can be selected from the following list:

Unit	Description
mbar	Millibar (1 mbar = 0,001 bar)
bar	Bar (1 bar = 1000 mbar = 10^5 Pa)
Pa	Pascal (1 Pa = 1 kg/(m*s ²) = 10^{-5} bar = 0,01 mbar)
hPa	Hectopascal (1 hPa = 100 Pa = 1 mbar)
kPa	Kilopascal (1 kPa = 1.000 Pa = 10 mbar)
MPa	Megapascal (1 MPa = 1.000.000 Pa = 10 bar)
g/cm ²	Gramme per square centimetre (1 g/cm ² = 0,981 mbar)
kg/cm ²	Kilogramme per square centimetre (1 kg/cm ² = 0,981 bar)
psi	Pound force per square inch (1 psi = 68,9 mbar)
atm	Atmospheric pressure (1 atm = 1013 mbar)
mmH ₂ O	Millimetre water column (1 mmH ₂ O = 0,0981 mbar)
mH ₂ O	Metre water column (1 mH ₂ O = 98,1 mbar)
inH ₂ O	Inch water column (1 inH ₂ O = 2,49 mbar)
ftH ₂ O	Foot water column (1 ftH ₂ O = 29,84 mbar)
torr	Torr (1 Torr = 1 mmHg = 1,33 mbar)
mmHg	Millimetre mercury column (1 mmHg = 1,33 mbar)
inHg	Inch mercury column (1 inHg = 33,86 mbar)

Table 19: Possible units for pressure

Unit Temperature

The unit in which the temperature is to be shown can be selected from the following list:

Unit	Description
°C	Degree Celsius
°F	Degree Fahrenheit ($T_{\text{Fahrenheit}} = T_{\text{Celsius}} * 1,8 + 32$)
°R	Degree Rankine ($T_{\text{Rankine}} = T_{\text{Kelvin}} * 1,8$)
K	Kelvin ($T_{\text{Kelvin}} = T_{\text{Celsius}} + 273,15$)

Table 20: Possible units for temperature

6.5.5.2 “Display mode” submenu

In the "Display mode" submenu, you configure the representation of the measured values and additional information on the display.

With the menu item “Screen layout” you configure the information that is displayed and its layout. Up to five values can be displayed at the same time. In the additional menu entries "1st value" to "5th value" you define the contents of the placeholders in the layout.

The various layouts as well as the possible content of the values are described in Chapter 6.3.4.

6.5.6 "Measurement/output" menu

In the "Measurement/output" menu, you configure the damping and measuring rate. In addition you select and parameterise the measurand to be shown at the current output.

Menu entry	Description
Damping	Setting the damping of the output signal
Measuring rate	Setting the measuring rate (20 or 100 Hz)
Select output value	Select value that shall be shown at the current output (height, volumen, weight or pressure)
Value at 4 mA	Value of the selected measurand that should correspond to 4 mA (lower range value)
Value at 20 mA	Value of the selected measurand that should correspond to 20 mA (upper range value)
Alarm current	Selection of the alarm current: High (>21 mA) or low (<3.6 mA)
Lower current limit	Limit of the lower output current (3.8...4.0 mA)
Upper current limit	Limit of the upper output current (20...21 mA)

Table 21: “Measurement/Output” menu

Independent from the setting of the upper and lower current limit, the set measuring range always corresponds to a current range of 4...20 mA.

6.5.6.1 Setting the damping

Using an adjustable damping you can eliminate fast pressure changes or peaks from having direct influence to the output signal. The set value in seconds corresponds to the time constant of an exponential rise. After a sudden pressure change, it takes the damping time to reach 63.2% of the actual pressure at the output. After the damping time has elapsed three times, 95% of the pressure is reached.

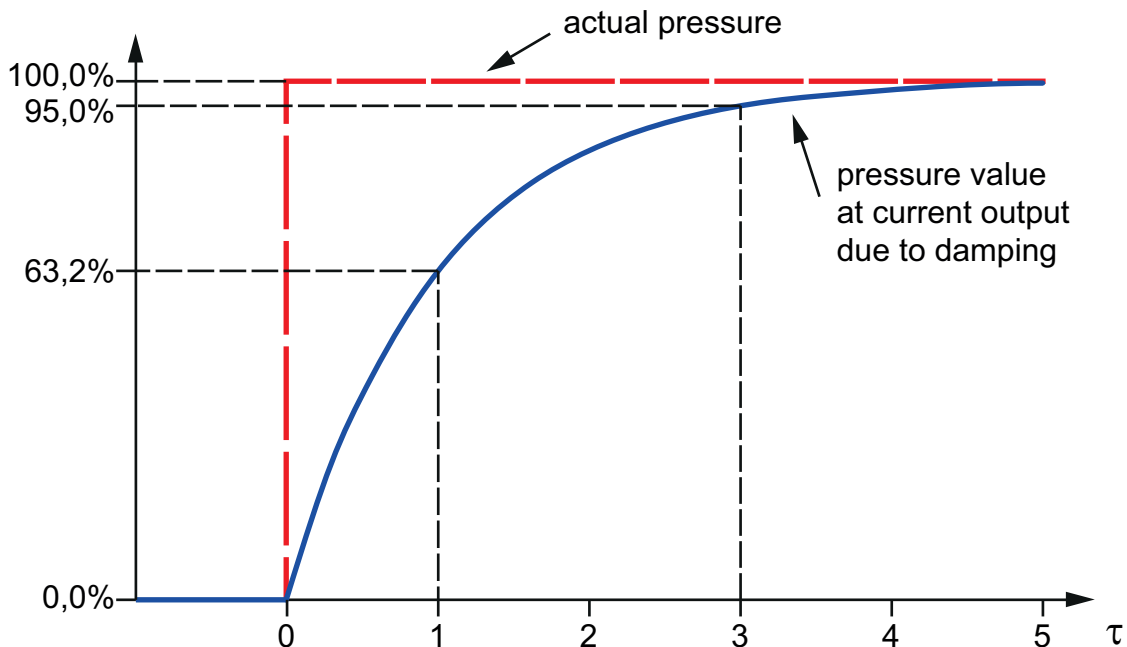

Figure 24: Damping effect

The damping affects the current output as well as the displayed pressure value.

6.5.6.2 Setting of the measuring rate

When shipped, the transmitter is set to a measuring rate of 20 Hz, i.e. 20 times per second the pressure is measured and the current is calculated and imprinted in the current loop. When a particularly fast measuring rate is required, for instance to detect pressure peaks, you can increase the measuring rate to 100 Hz. This can lead to the following restrictions:

- Communication via HART can be disturbed by fast pressure changes.
- The measuring signal can be noisier.

For this reason, you should only increase the measuring rate to 100 Hz if necessary for the application.

6.5.6.3 Upper and lower current limit

In the standard setting, the current output is limited at 3.8 and 20.5 mA, meaning a further drop or rise in the measured variable does not change the current. You can freely select these current limits for the lower limit between 3.8 and 4 mA and for the upper limit between 20 and 21 mA.

6.5.7 "Diagnosis" menu

In this menu you can view and configure various diagnostic information. The following diagnostic functions are available:

Menu entry	Description
Counter	Display of operating hour counter and maintenance timer
Min/max values	Displaying and resetting the min/max values for the different measured variables
Last error	Display and reset of the last critical error
Self test	Self test of the device like after applying the power supply
Maintenance timer	Management of maintenance intervals

Table 22: "Diagnosis" menu

6.5.7.1 Min/Max values

The min/max values save the maximum and minimum values of the different measurands until they are reset by the user. The menu item that shows the min/max value, can also be used to reset it. Some of the min/max values are also directly accessible from the measured value display in the device data (see 6.3.1).

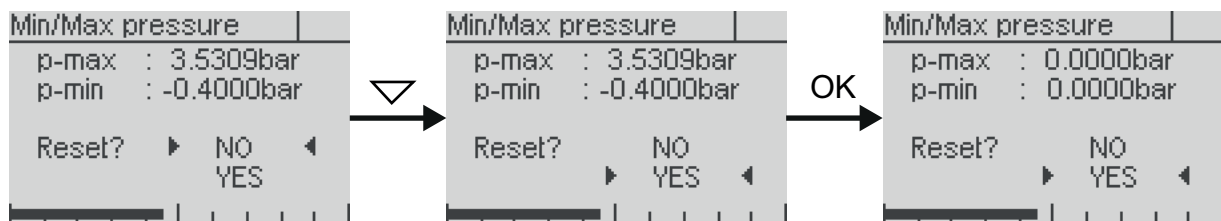

Figure 25: Display and resetting of the Min/Max values for pressure

6.5.7.2 The maintenance timer

Using the maintenance timer, the device can signal the need for maintenance after a freely selectable number of operating hours. The timer counts down from the start value. Maintenance need is indicated by an icon in the display (see 6.3.3) and, if necessary, the HART protocol.

When the maintenance timer has expired, the counter continues into the minus range thus the degree to which the interval has been exceeded is also visible.

Menu entry	Description
Current simulation	Setting a fixed current value
Pressure Simulation	Setting a fixed pressure value

Table 23: Maintenance timer" submenu

6.5.8 „Simulation“ menue

The different measurands and the current can be simulated in the "Simulation" menue to check the subsequent processing of measured values.

The current simulation only affects the current output. The measurand simulations take all settings into account, i.e. including the damping and active tank shape if necessary.

If the simulated variable has no effect on the current output, the measured value of the selected variable continues to be issued at the current output. For example, you may have selected the fill height as the variable for the current output and then simulate the volume. In this case, the measured fill height continues to be issued at the current output as the volume calculation is only done after the fill height calculation (see also 6.1.5)

6.5.9 Communication menue

In the "Communication" menue the settings for the HART communication are summarised.

Menue entry	Description
HART address	Setting the HART address for device identification in multi-drop mode
Current mode	Setting the current mode (proportional/constant)
HART data	Display of HART information (HART tag, HART descriptor, etc.)
Send-preambles	Setting of the number of send-preambles for HART communication

Table 24: "Communication" menue

6.5.9.1 HART address

This address corresponds with the short address which is used for the HART-Communication. It can be set within a range of 0 to 63. Please note, that setting the short address between 1 and 63 will not automatically activate the constant current mode. This must be done under the menue "Current mode" (see Chapter 6.5.9.2).

6.5.9.2 Current mode

The current mode determines whether the output current of the device is set to respond proportionally to the pressure (selection "proportional") or whether it should remain constant at 4 mA (selection "constant"). When the current mode "constant" is in use the measurement value can be read using HART only (e.g. for HART-multidrop-operation).

6.5.10 "System" menue

In the "System" menue, device-relevant functions are summarised.

Menue entry	Description
Device ID	Setting the device ID (e.g. to display a free-text in the display)
Device data	Display of device data (such as from measured value display)
Factory data reset	Reset to factory settings
Restart	Restarting the device (such as after a power outage)
Config.-memory	Configuration memory: reading, writing and status

Table 25: "System" menue

6.5.10.1 Device ID

Using the device ID, you can show a custom text in the display if you configure the display mode accordingly (see 6.3.4). For instance, you can show the tag number continuously in the display.

The device ID can be up to 16 characters long and consist of numbers, empty spaces, capital letters and special characters.

For the selection, the characters are arranged in the order shown below. From the end of the list (special character "@"), you are automatically guided back to the start (number "0").

Character set:

0123456789 ABCDEFGHIJKLMNOPQRSTUVWXYZ[\]^_!"#\$%&'()*+,-./:;<=>?@

6.5.10.2 Factory reset

When carrying out a factory reset, all parameters are set to the state at the time of delivery. This also includes the pressure and current adjustment. Exceptions are the following operational parameters: "Min/max values", "change counter" and "operation hours".

6.5.10.3 Configuration memory

You can store all device parameters in the configuration memory of the display module. You can transfer the data back to the device or to another device. Transferring a configuration to another device requires a compatible target device. The same nominal range is not necessary. It is sufficient if the measuring range of the stored configuration is equal or smaller than the nominal range of the target device.

The configuration memory contains the parameter setting of the device at the time of storage. If you change a device parameter afterwards, the stored configuration will not be updated automatically.

The status screen of the configuration memory contains the following information:

- Available YES: the display module contains a stored configuration
 NO: no stored configuration
- Source this device: the stored configuration originates from the connected device
 Serial#: the stored configuration originates from the device with the listed serial number.
- Up-to-date YES: The device configuration has not been changed since the parameter set has been stored in the display module
 NO: The device configuration has been changed

The transfer of a configuration takes approx. 25 seconds. If you use a table function with many support points the transfer can take up to 50 seconds.

6.5.11 Overview with menu tree and device functions

Quick Setup	
— Language...	Select menu language
— Level wizard...	Guided parameterisation of the level measurement
— Damping...	Setting the damping of the output signal
— Device ID...	Setting the device ID
— Config.-memory	Configuration memory: reading, writing and status
Level	
— Level wizard...	Guided parameterisation of the level measurement
— Density	Parameterising the density
— ...	<i>Submenus (view/edit, teach, unit)</i>
— Height offset	Parameterising the height offset
— ...	<i>Submenus (view/edit, teach, unit)</i>
— Tank shape	Parameterising the tank shape
— ...	<i>Submenus (view/edit, teach, units, etc.)</i>
— Status	Display status of level measurement
Adjustment	
— Pressure Adjustment	Adjustment of the pressure measurement
— Zero Point...	Set device at ambient pressure to zero (0 bar rel) (only for gauge pressure devices)
— Position Correction	Correct zero point error due to installation position (only for gauge pressure devices)
— ...	<i>Set, activate and deactivate position correction</i>
— Lower Adjustment...	Offset correction with applied reference pressure
— Upper Adjustment...	Span correction with applied reference pressure
— Current Adjustment	Adjustment of the current output
— 4 mA...	Adjust 4mA
— 20 mA...	Adjust 20 mA
Display	
— Language...	Select menu language
— Units	Select units for measurands and parameters
— Height...	Select unit for fill height and height offset
— ...	<i>More units</i>
— Display Mode	Configuration of the display layout and content
— Screen Layout...	Define screen structure and layout
— 1st value...	Content for 1st value in the selected layout
— ...	<i>Content for further values (up to five)</i>
— Decimal Point...	Selection of the decimal places by specifying the decimal point
— Backlight...	Switch backlight on/off
Measurement/Output	
— Damping...	Setting the damping of the output signal
— Measuring Rate...	Setting of the measuring rate (20 or 100 Hz)
— Output value	Select measurand that shall be shown at the current output
— Value at 4 mA	Value of selected measurand that shall correspond to 4 mA
— view / edit...	View and edit value for 4 mA
— teach...	Teach value for 4 mA
— Value at 20 mA	Value of selected measurand that shall correspond to 4 mA
— view / edit...	View and edit value for 20 mA
— teach...	Teach value for 20 mA
— Alarm Current...	Selection of the alarm current: High (>21 mA) or low (<3.6 mA)
— Lower Current Limit...	Limit of the lower output current (3.8...4.0 mA)
— Upper Current Limit...	Limit of the upper output current (20...21 mA)
Diagnosis	
— Counters...	Display of operating hour counter and maintenance timer
— Min/max-values	Display and reset min/max-Values for the different output values
— ...	<i>Display and reset the different Min/Max-values</i>
— Last error...	Display and reset of the last critical error
— Self test...	Self test of the device like after applying the power supply
— Maintenance timer	Management of maintenance intervals
— Status...	Displaying and stopping the maintenance timer
— Set interval...	Setting and starting the maintenance timer
Simulation	
— Current...	Setting a fixed current value
— Pressure...	Setting a fixed pressure value
— Height...	Setting a fixed height value
— ...	<i>Setting other output values</i>
Communication	
— HART address...	Setting the HART address for device identification in multi-drop mode
— Current mode...	Setting the current mode (proportional/constant)
— HART data...	Display of HART information (HART tag, HART descriptor, etc.)
— Send-preambles...	Setting of the number of send preambles for HART communication
System	
— Device ID...	Setting the device ID (e.g. to display a free-text in the display)
— Device data...	Display of device data (same as from measured value display)
— ...	Various screens with device data
— Factory reset...	Reset to factory settings
— Device reset...	Restarting the device (such as after a power outage)
— Config.-memory	Configuration memory: reading, writing and status