

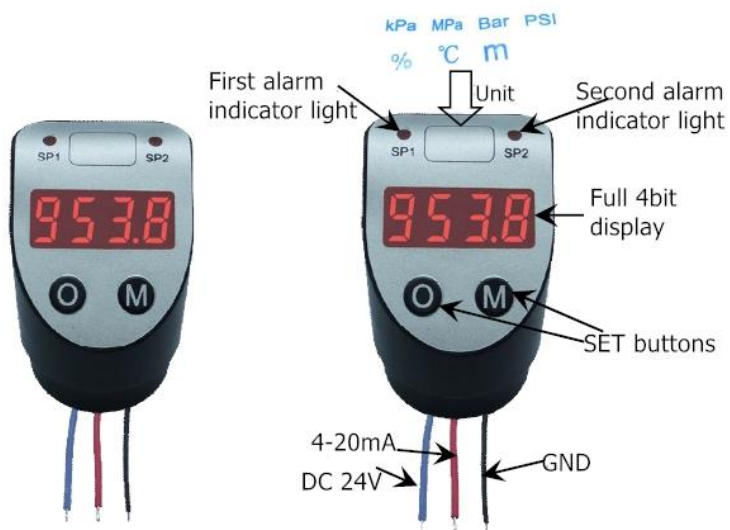

Pressure Transmitter- Intelligent LCD & LED indicators



Wiring  Screw-in



GX12-5 female connector M12-5 female connector

Description

2 wire intelligent loop current indicator suits for all kinds of 316SS Pressure transmitters (our model: 401B/402B/421B/435B/435D).

This indicator is stable and reliable, it has 4 bits display according to 4-20mA signal coming from pressure transmitter. 2-ways alarm output, when an alarm is triggered, corresponding alarm light on the panel will blink.

Relay output alarm type indicator with built-in relay, contacts can active directly actuator by the nearest 1A current.

Feature

Through current: measure range 3~22mA ; ultimate overload <100mA;

Display type: LED digital and decimal, height 8.0mm red.

Relative humidity: 20%~90%RH

Normal service volt drop <= 4V, 20mA over current protection

Display setting range: 4mA: -1999~ 9999; -1999~9999

Pressure Transmitter- Intelligent LCD & LED indicators

Standard indicator Code: MB

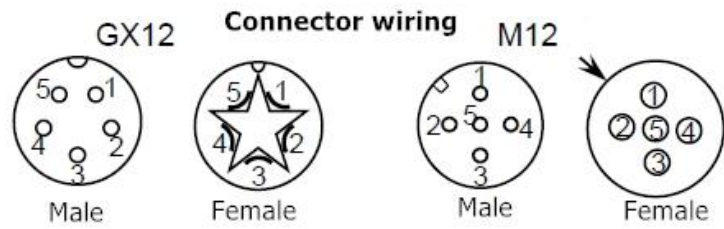
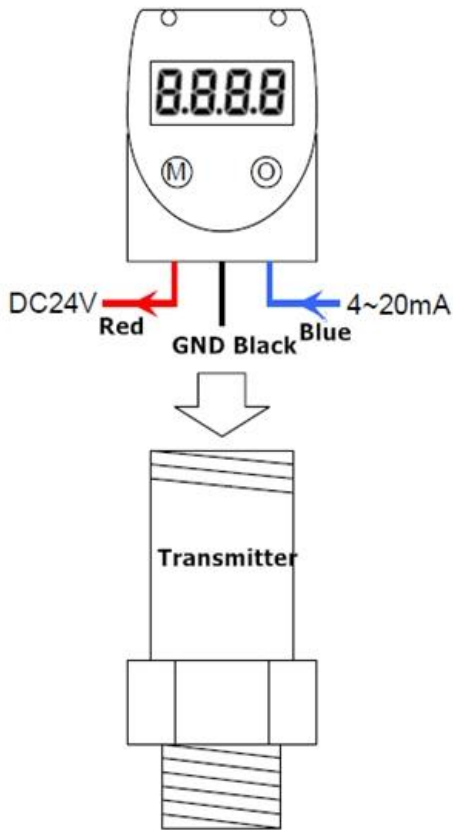

Terminal	Wiring define
1	DC24V input
2	Null
3	GND
4	Null
5	4-20mA current output

MB, Standard LED indicator + Pressure transmitter

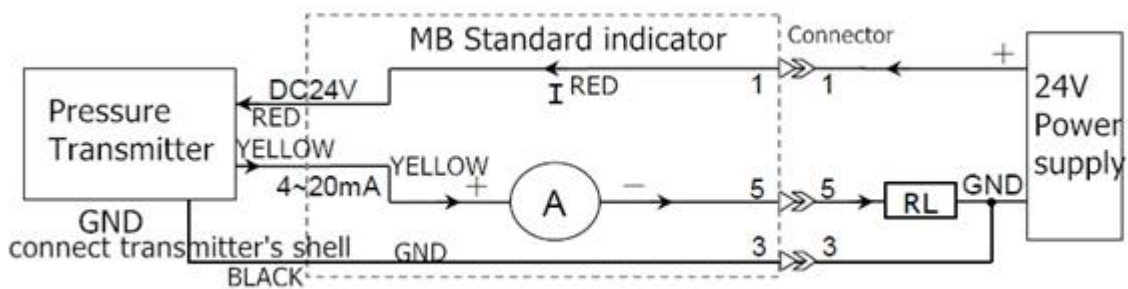

(Standard LED indicator without alarm Code:MB)

Pressure Transmitter- Intelligent LCD & LED indicators

Relay Alarm indicator Code: MH

When an alarm is triggered, corresponding alarm light on the panel will blink. Alarm indicator send out relay signal, high-level output (PNP) and low-level output (NPN) is optional. Usually default to provide a low-level output type (NPN), that is, when triggering alarm, alarm terminal is connected to GND and through 1A current.

If use this alarm type indicator, please ensure that the wire of A1, A2 relay contact and GND (type P is DC24V wire) enough to through 1~2A current. Relay switch lifetime is 100,000 times, therefore it is not suitable for frequent switching application.

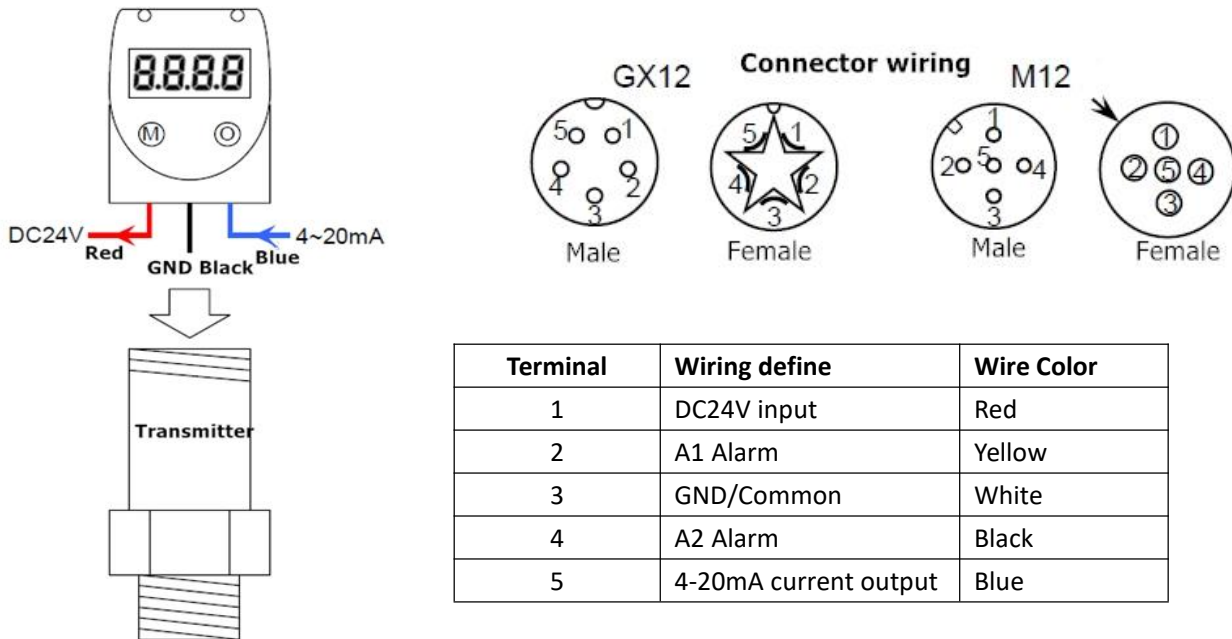

MH, LED indicator with 2-ways relay Alarms + Pressure transmitter

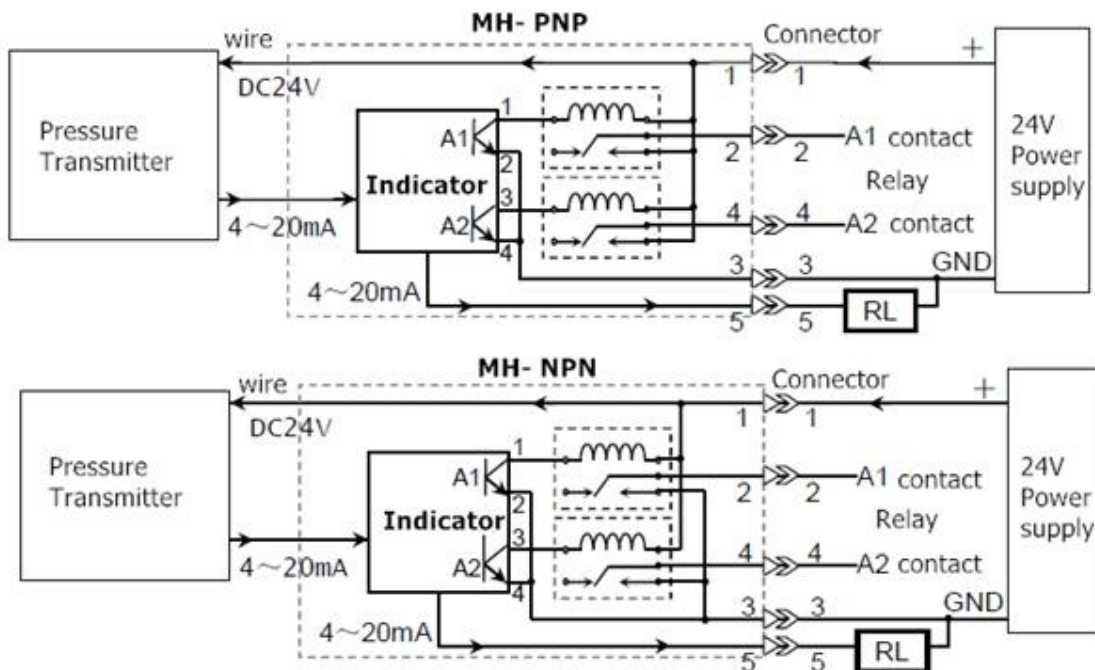

(LED indicator with 2-ways relay Alarms Code: MH)

Pressure Transmitter- Intelligent LCD & LED indicators

Operation

Key "O" (Option) is used for switching menu and move the flash.

Key "M" (Modify) is used for entering menu and modify the flash and confirm modify operation.

In any menu (except advanced settings), long press "O" for 3 seconds to save the current modification and exit. In any menu, no operation for 10 seconds, operation will recover to measurement status automatically. In measurement status, press "O" one time will display the present current value for 3s (such as 15.23, means the present input current is 15.23mA), after 3s it will recover automatically to measurement status.



Menu 1: Measurement set up menu (password 0011).

In measurement status and press "O" & "M" at the same time for 3s will enter to password status, press "O" to move cursor, press "M" to input password 0011, then long press "O" to enter measurement setting menu, in this menu press "O" to switch menu and press "M" enter its submenu.

 (SE-1): set up 4mA display value, after entering this menu press "O" to switch cursor, and press "M" to add the digit, when you finish the setting, please long press "O" 3s to save and exit. For

example: .

 (SE-2): set up 20mA display value, please refer to SE-1.

 (SE-3): set up decimal point. After entering, press "M" to move decimal point, long press "O" 3s to save and exit. For example: .



 (SE-4): set up unit symbol. After entering this menu, press "M" to move unit symbol place. when you finish the setting, please long press "O" 3s to save and exit. Notice: this menu only for LCD indicator.

Menu 2: Alarm setting (password 0022)

Standard LED indicator is without this menu. After input password 0022, long press "O" to enter this menu.

 (AL-1): set up the control value of alarm contact 1, after entering this menu, press "O" to switch cursor, and press "M" to add the digit, when you complete this setting, please long press "O" 3s to save and exit.

 (AL-2): set up the control value of alarm contact 2, please refer to (AL-1).

 (AL-3): set up alarm time-delay, after entering this menu, press "O" to switch cursor, and press "M" to add the digit, when you complete this setting, please keep press "O" 3s to save and exit. Max. set 0~99s. If the value is 0, that is no time-delay. After setting time-delay, when reaching alarm (control) value, it will not alarm immediately, but will keep display value for seconds (AL-3 value) and then alarm starts work. Also require seconds to disarm the alarm status. For example: .

Pressure Transmitter- Intelligent LCD & LED indicators

AL4 (AL-4): set up alarm return difference, after entering this menu, press “O” to switch cursor, and press “M” to add the digit, when you complete this setting, please keep press “O” 3s to save and exit. When sets this value is ‘0’, that is no return difference. For example: AL-1 is 3000 ↑ , AL-4 is 200. When value more than 3000 and start alarm; when the value reading is 2999, the alarm state will not be removed until this value lower than 2800.

AL5 (AL-5): set up alarm point state, after entering this menu, press “O” to switch cursor, and press “M” to change flashing digit state. The first flashing digit correspond to alarm 1, the second flashing digit correspond to alarm 2. There are 3 flashing digit states: “— —” (No alarm), LO (Alarm when lower than control value), HI (Alarm when higher than control value). For example: **HIHI**, when measured value is higher than alarm 1(AL-1) setting value, will enter alarm state; and alarm 2 (AL-2) NO alarm no matter how the case is.

AL6 (AL-6): set up alarm state, press “M” to switch the state after entering this menu. 2 states: “ON” and “OFF”. If “ON”, when start alarm, indicator will switch display alarm state and measuring state. For example: **HIHI**, HI, LO means alarm state , -1, -2 is alarm point.

Menu 3: Advanced set up menu (password 0033).

After input password 0033, long press “O” to enter this menu. Notice: Non-professionals do not use this menu, please.

SP1 (SP-1): calibrate standard sample 4mA. After entering this menu will display 0.004, input standard 4mA current signal, press “M” 1s will automatically return to “Menu 2”, at this time, the current input 4mA has been saved as standard sample.

SP2 (SP-2): calibrate standard sample 20mA. After entering this menu will display 0.020, input standard 20mA current signal, press “M” 1s will automatically return to “Menu 2”, at this time, the current input 20mA has been saved as standard sample.

Notice: (SP-1), (SP-2) please input standard current, if input wrong current or bad accuracy, which may affect measurement’s precision.

SP3 (SP-3): initialization setting. After entering press ‘M’ will reset all settings of this indicator.

Notice: this function can be used only due to unknown circumstances result in the indicator dysfunction, and can not be restored through the normal setting. Please caution, after use this function, all settings of (SP-1),(SP-2),(SE-1~4) ,(AL-1~4) will be lost. They have to be reset.

Pressure Transmitter- Intelligent LCD & LED indicators

